

# Interference phenomena in superconductor - ferromagnet hybrids

**A. Buzdin**

*University of Bordeaux and Institut Universitaire de France*



*in collaboration with  
A. Melnikov, A. Samokhvalov, R. Shekhter*

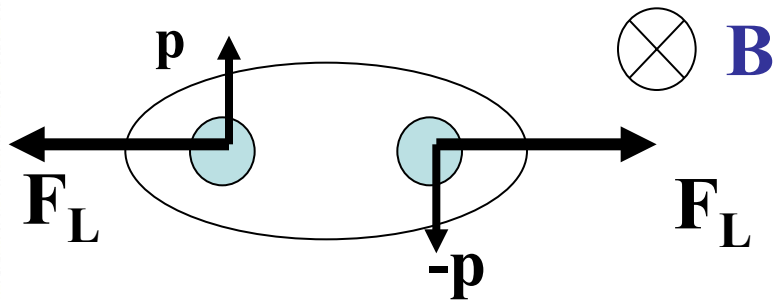
**CPTGA international workshop  
“Strongly disordered and inhomogeneous superconductivity”  
November, 21-22 , Grenoble, France**

# Outline

- Origin and the main peculiarities of the proximity effect in superconductor-ferromagnet systems.
- Josephson  $\pi$ -junction.
- Interference phenomena in superconductor -ferromagnet hybrids
- Perspectives and possible applications.

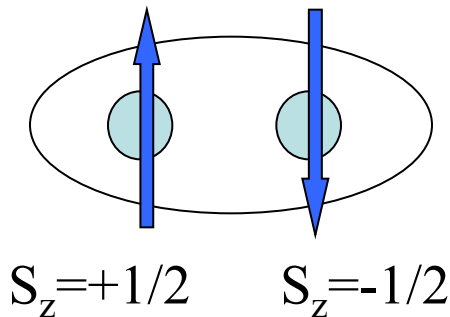
# Antagonism of magnetism (ferromagnetism) and superconductivity

- Orbital effect (Lorentz force)



*Electromagnetic mechanism  
(breakdown of Cooper pairs  
by magnetic field  
induced by magnetic moment)*

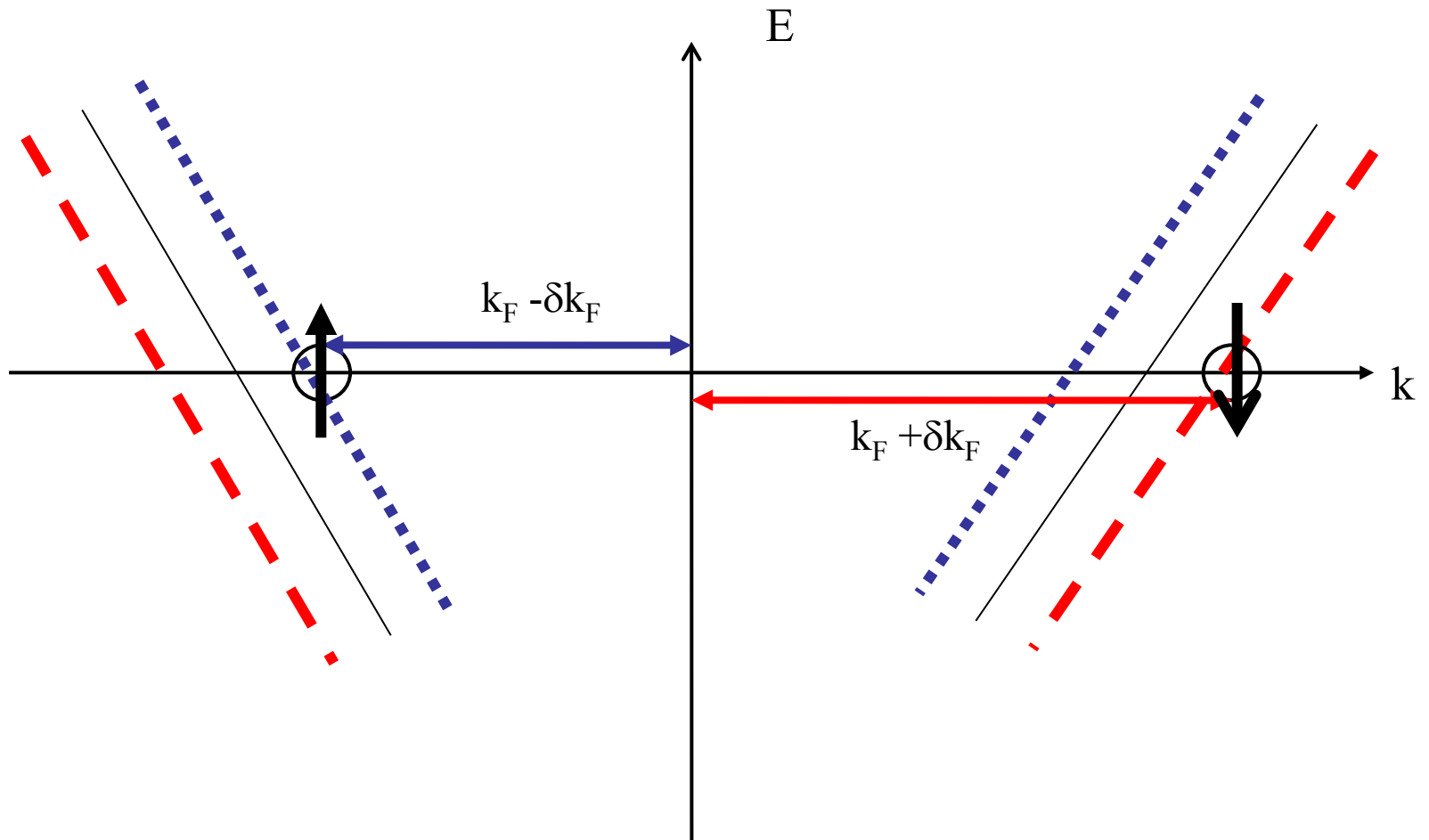
- Paramagnetic effect (singlet pair)



$$\mu_B H \sim \Delta \sim T_c$$

$$I(\vec{S} \cdot \vec{s}) \approx T_c$$

*Exchange interaction*



The total momentum of the Cooper pair is  
 $-(k_F - \delta k_F) + (k_F - \delta k_F) = 2 \delta k_F$

# FFLO inventors



Fulde and Ferrell



Larkin and Ovchinnikov

P. Fulde, R. A. Ferrell, Phys.Rev. **135**, A550 (1964)

A. I. Larkin, Yu. N. Ovchinnikov, JETP **47**, 1138 (1964)

# Superconducting order parameter behavior in ferromagnet

Standard Ginzburg-Landau functional:

$$F = a|\Psi|^2 + \frac{1}{4m}|\nabla\Psi|^2 + \frac{b}{2}|\Psi|^4$$

The minimum energy corresponds to  $\Psi = \text{const}$

**The coefficients of GL functional are functions of internal exchange field  $h$  !**

**Modified Ginzburg-Landau functional ! :**

$$F = a|\Psi|^2 - \gamma|\nabla\Psi|^2 + \eta|\nabla^2\Psi|^2 + \dots$$

The **non-uniform** state  $\Psi \sim \exp(iqr)$  will correspond to minimum energy and higher transition temperature

## Proximity effect in a ferromagnet ?

In the usual case (S with normal metal) :

$$a\Psi - \frac{1}{4m} \nabla^2 \Psi = 0, \text{ and solution for } T > T_c \text{ is } \Psi \propto e^{-qx}, \text{ where } q = \sqrt{4ma}$$

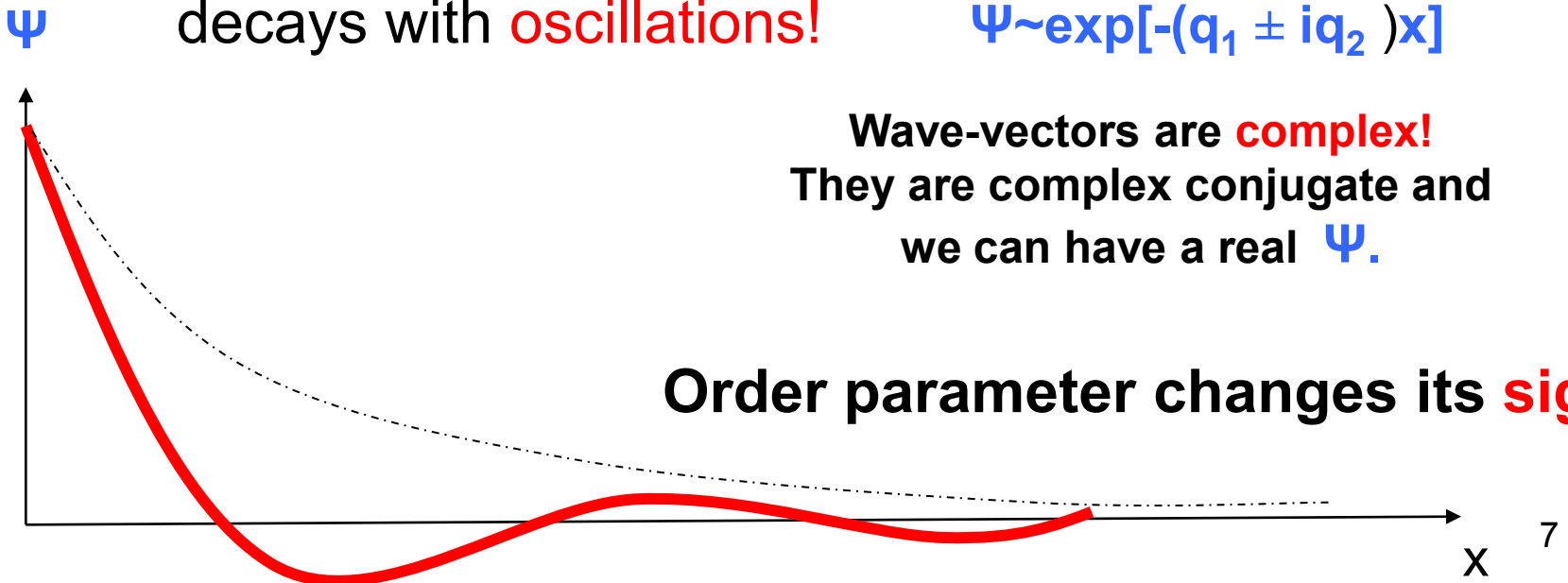
In **ferromagnet** ( in presence of exchange field) the equation for superconducting order parameter is different

$$a\Psi + \gamma \nabla^2 \Psi - \eta \nabla^4 \Psi = 0$$

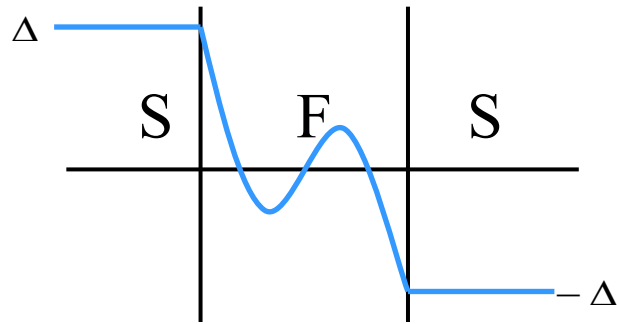
Its solution corresponds to the order parameter which decays with **oscillations!**  $\Psi \sim \exp[-(q_1 \pm iq_2)x]$

Wave-vectors are **complex!**  
They are complex conjugate and  
we can have a real  $\Psi$ .

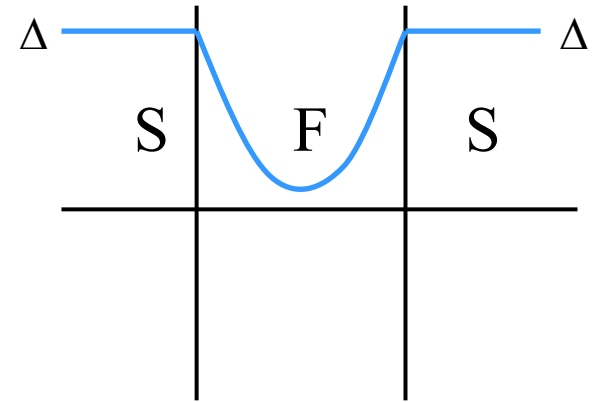
Order parameter changes its **sign!**



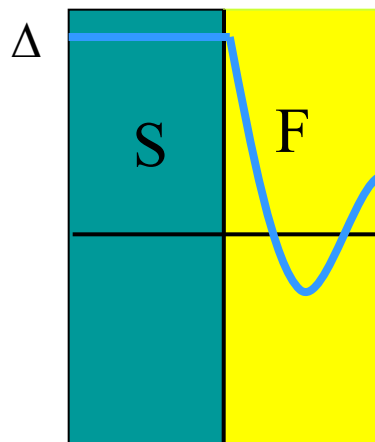
Remarkable effects come from the possible **shift of sign** of the wave function in the ferromagnet, allowing the possibility of a **«  $\pi$ -coupling »** between the two superconductors ( $\pi$ -phase difference instead of the usual zero-phase difference)



«  $\pi$  phase »



« 0 phase »



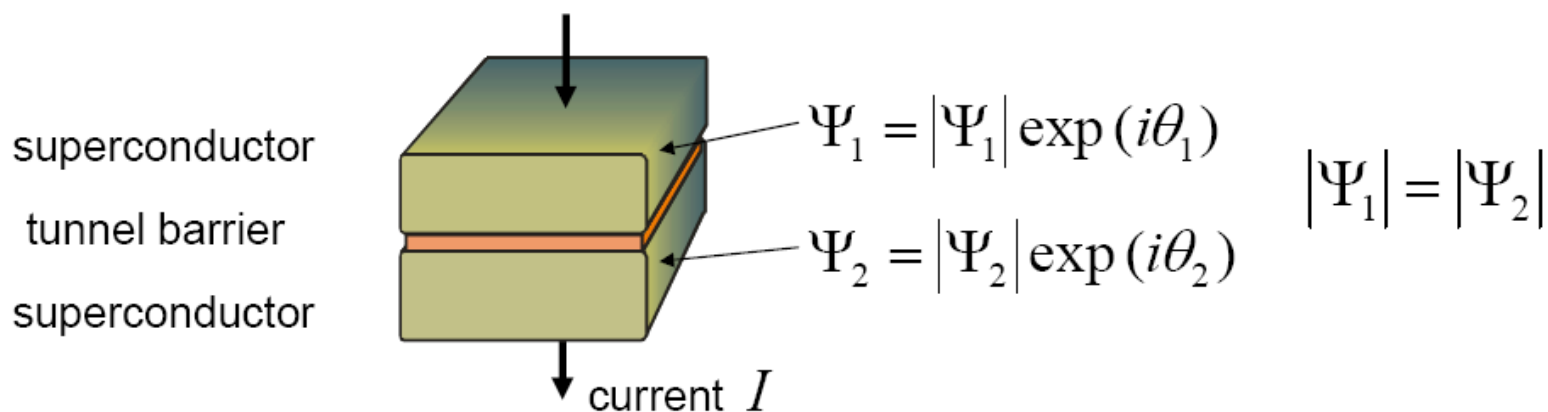
S/F bilayer

$$\xi_f = \sqrt{D_f / \hbar} \ll \xi_s$$

**$\hbar$ -exchange field,**  
 **$D_f$ - diffusion constant** 8



# Josephson effect



superconducting phase difference:  $\varphi = \theta_1 - \theta_2$

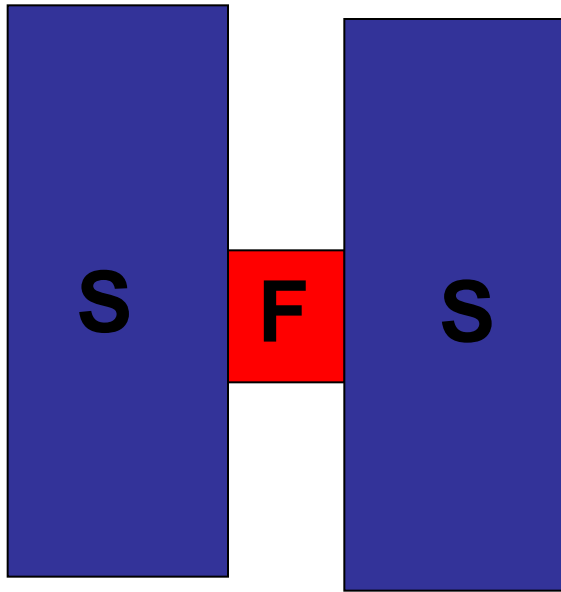
Josephson relations

$$\begin{cases} I_s = I_c \sin \varphi \\ V = \frac{\hbar}{2e} \frac{d\varphi}{dt} \end{cases}$$

Electromagnetic radiation at the frequency  $f$

$$f = \frac{V}{\Phi_0}$$

# S-F-S Josephson junction in the clean/dirty limit

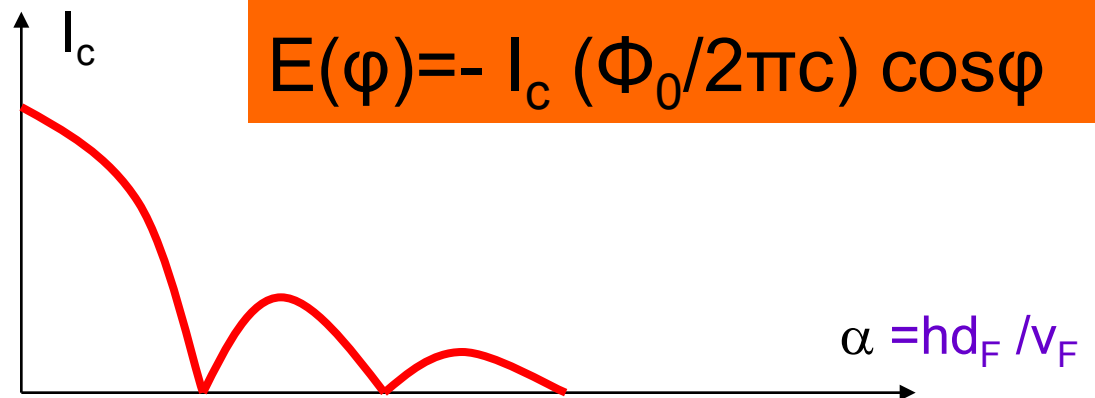


Damping oscillating dependence of the critical current  $I_c$  as the function of the parameter  $\alpha = \hbar d_F / v_F$  has been predicted.

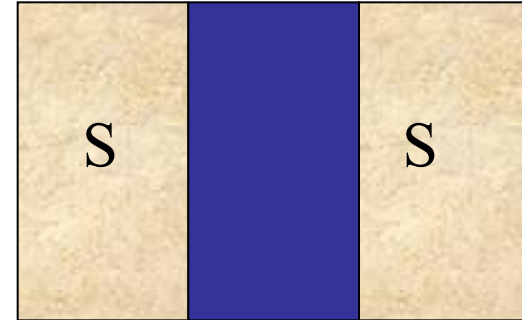
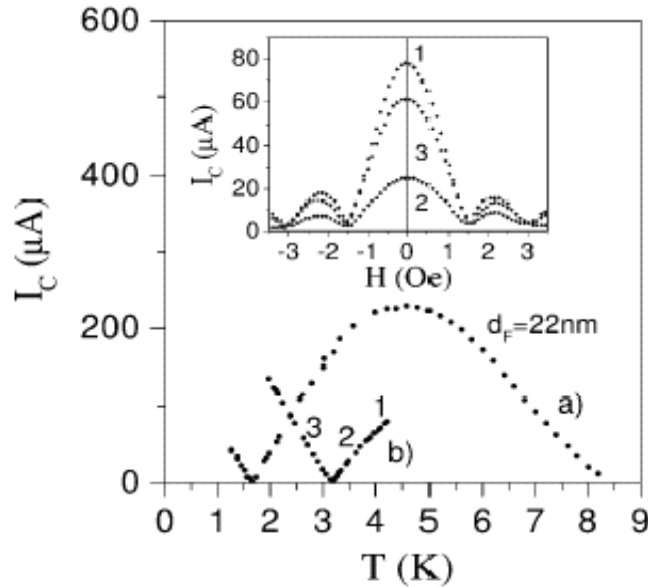
(Buzdin, Bulaevskii and Panjukov, JETP Lett. 81)

$\hbar$ - exchange field in the ferromagnet,  
 $d_F$  - its thickness

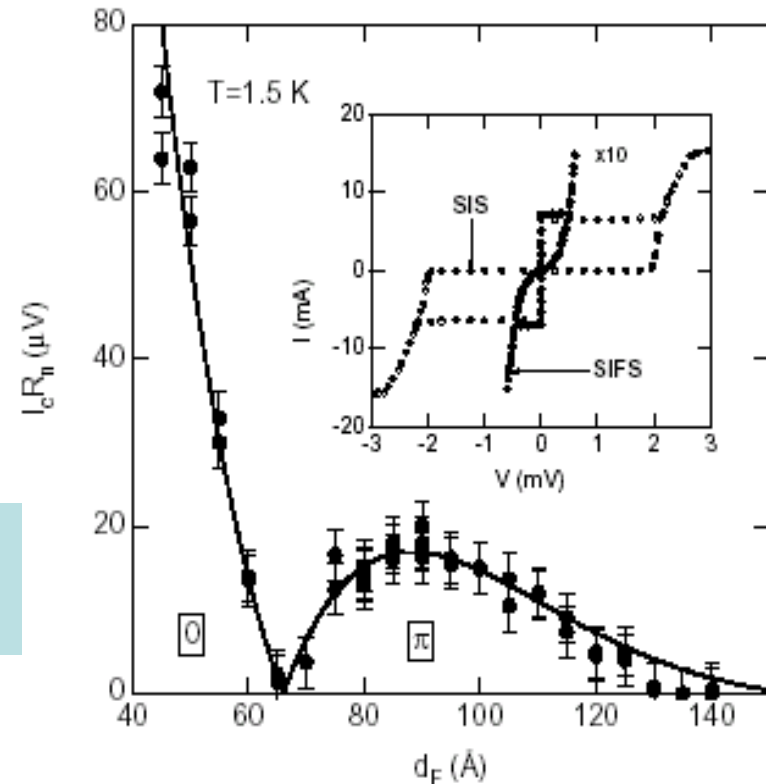
$$J(\varphi) = I_c \sin \varphi$$



The oscillations of the critical current as a function of temperature (for different thickness of the ferromagnet) in S/F/S trilayers have been observed on experiment by **Ryazanov et al. 2000, PRL**



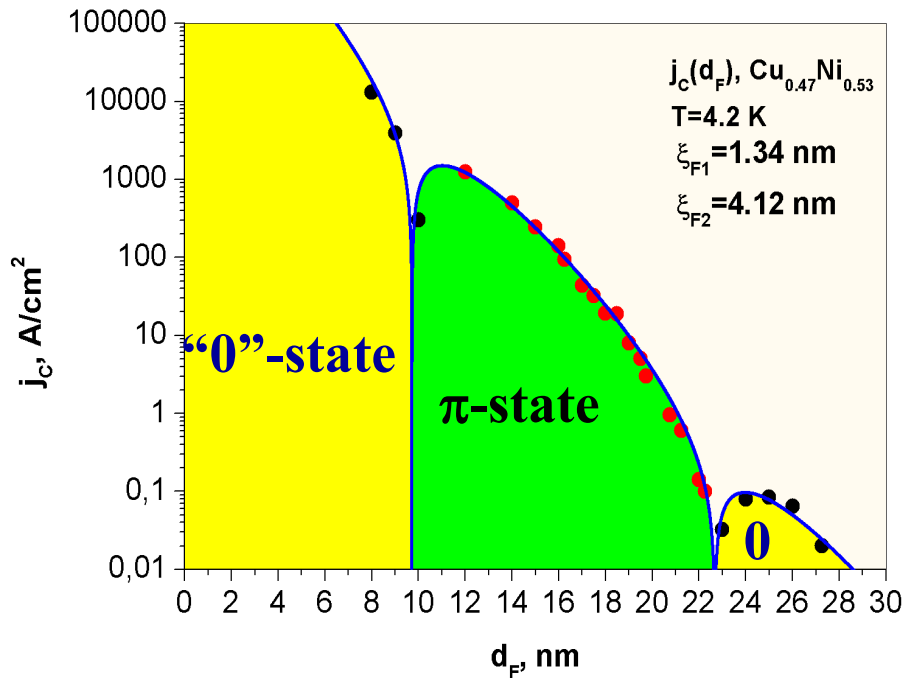
and as a function of a ferromagnetic layer thickness by **Kontos et al. 2002, PRL**



# Critical current density vs. F-layer thickness

(V.A. Oboznov et al., PRL, 2006)

$$I_c = I_{c0} \exp(-d_F / \xi_{F1}) |\cos(d_F / \xi_{F2}) + \sin(d_F / \xi_{F2})|$$



$$d_F \gg \xi_{F1}$$

Spin-flip scattering decreases the decaying length and increases the oscillation period.

$$\xi_{F2} > \xi_{F1}$$

Nb-Cu<sub>0.47</sub>Ni<sub>0.53</sub>-Nb

“0”-state

$$I = I_c \sin \varphi$$

$\pi$ -state

$$I = I_c \sin(\varphi + \pi) = -I_c \sin(\varphi)$$

# Phase-sensitive experiments

## $\pi$ -junction in one-contact interferometer

**0-junction**  
minimum energy at 0

**$\pi$ -junction**  
minimum energy at  $\pi$

$$I = I_c \sin(\pi + \phi) = -I_c \sin \phi$$

$$E = E_J [1 - \cos(\pi + \phi)] = E_J [1 + \cos \phi]$$

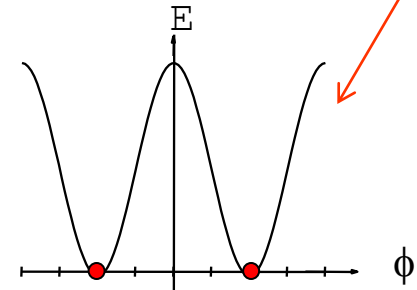
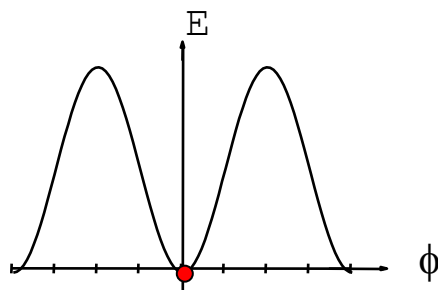
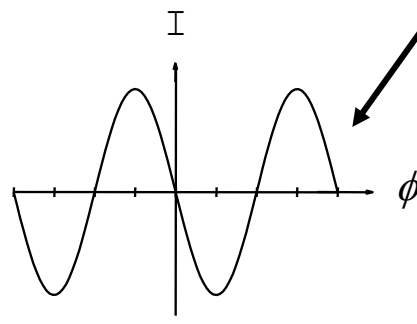
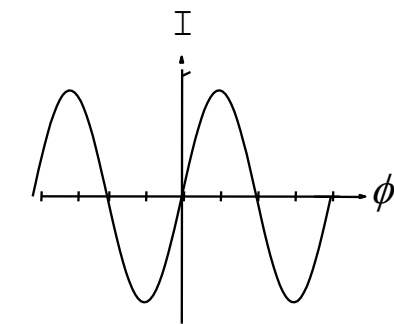
$$2\pi L I_c > \Phi_0 / 2$$

$$\begin{aligned} \phi = \pi = \\ (2\pi / \Phi_0) \int A dl \\ = 2\pi \Phi / \Phi_0 \end{aligned}$$

Spontaneous circulating current  
in a closed superconducting loop  
when  $\beta_L > 1$  with NO applied flux

$$\beta_L = \Phi_0 / (4\pi L I_c)$$

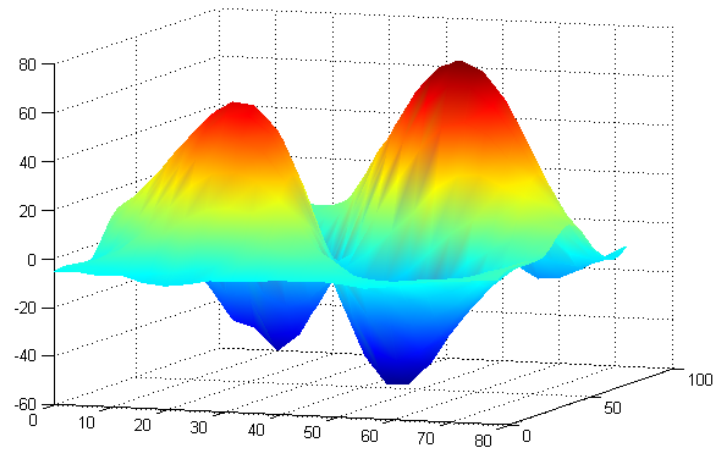
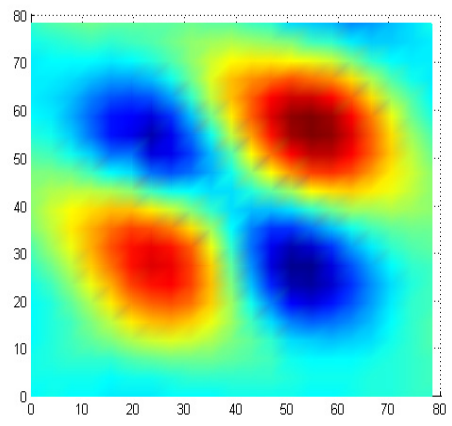
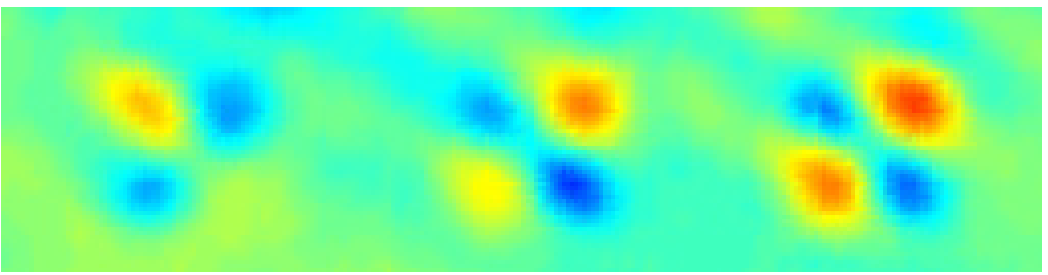
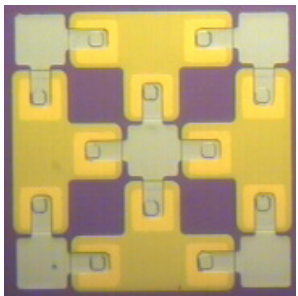
$$\Phi = \Phi_0 / 2$$



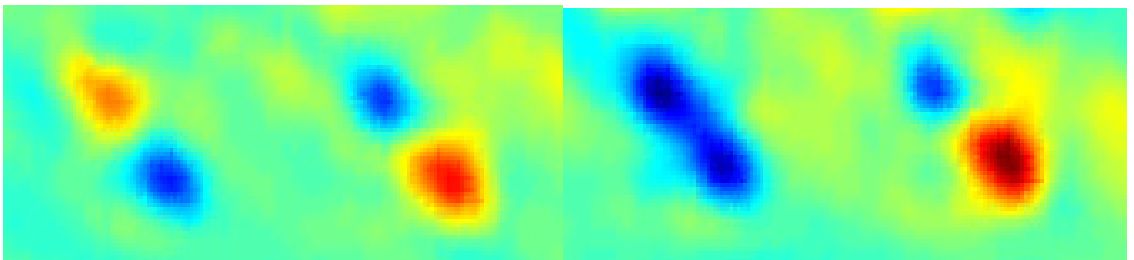
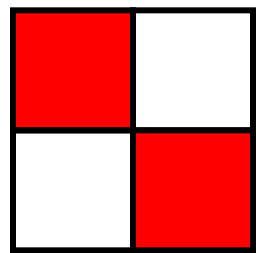
Bulaevsky, Kuzii, Sobyenin, JETP Lett. 1977

# 2 x 2 arrays: spontaneous vortices

Fully frustrated



Checkerboard frustrated



# Triplet correlations

Bergeret, Volkov, Efetov (2001) and Kadigrobov, Shekhter, Jonson (2001)

$$D\partial_x^2 \hat{f} - 2|\omega| \hat{f} + i \operatorname{sgn}(\omega) (\hat{f} \hat{V}^* - \hat{V} \hat{f}) = 0 \quad \hat{V} = J \begin{pmatrix} \cos \alpha & \pm i \sin \alpha \\ \mp i \sin \alpha & -\cos \alpha \end{pmatrix}$$

Structure of the functions  $f$ :

$$f = i \hat{\tau}_2 (f_3(x) \hat{\sigma}_3 + f_0(x)) + i \hat{\tau}_1 \hat{\sigma}_1 f_1(x)$$

$\sigma, \tau$  - Pauli matrices  
(spin, Nambu)

$$f_3 \propto \langle \psi_\uparrow \psi_\downarrow \rangle - \langle \psi_\downarrow \psi_\uparrow \rangle$$

-Singlet condensate

$$f_0 \propto \langle \psi_\uparrow \psi_\downarrow \rangle + \langle \psi_\downarrow \psi_\uparrow \rangle$$

-Triplet condensate (with projection 0 on z-axis)

$$f_1 \propto \langle \psi_\uparrow \psi_\uparrow \rangle \propto \langle \psi_\downarrow \psi_\downarrow \rangle$$

-Triplet condensate (with projection +1, -1)

8

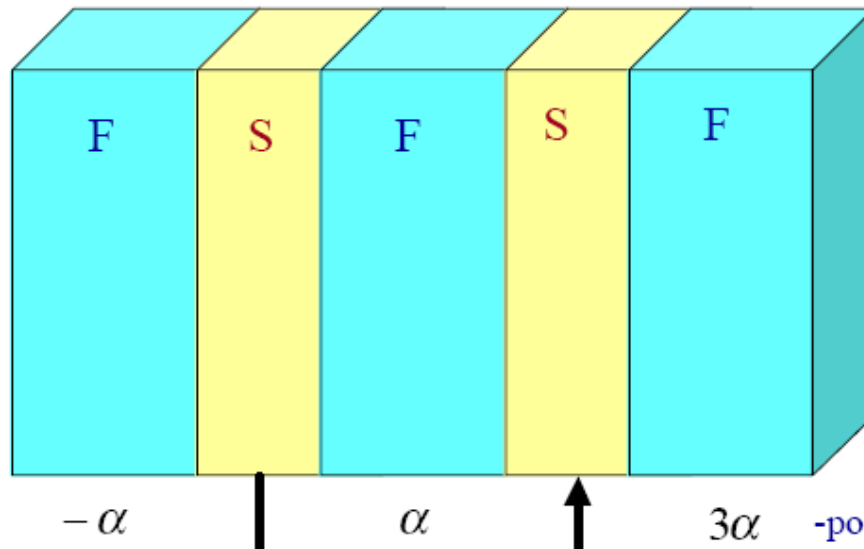


TABLE I. Characteristic length scales of S/F proximity effect.

Thermal diffusion length  $L_T$

$$\sqrt{\frac{D}{2\pi T}}$$

Superconducting coherence length  $\xi_s$

$$\frac{v_{Fs}}{2\pi T_c} \text{ in pure limit}$$

$$\sqrt{\frac{D_s}{2\pi T_c}} \text{ in dirty limit}$$

Superconducting correlation decay length  $\xi_{1f}$  in a ferromagnet

$$\frac{v_{Ff}}{2\pi T} \text{ in pure limit}$$

$$\xi_f = \sqrt{\frac{D_f}{h}} \text{ in dirty limit}$$

Superconducting correlation oscillating length  $\xi_{2f}$  in a ferromagnet

$$\frac{v_{Ff}}{2h} \text{ in pure limit}$$

$$\xi_f = \sqrt{\frac{D_f}{h}} \text{ in dirty limit}$$

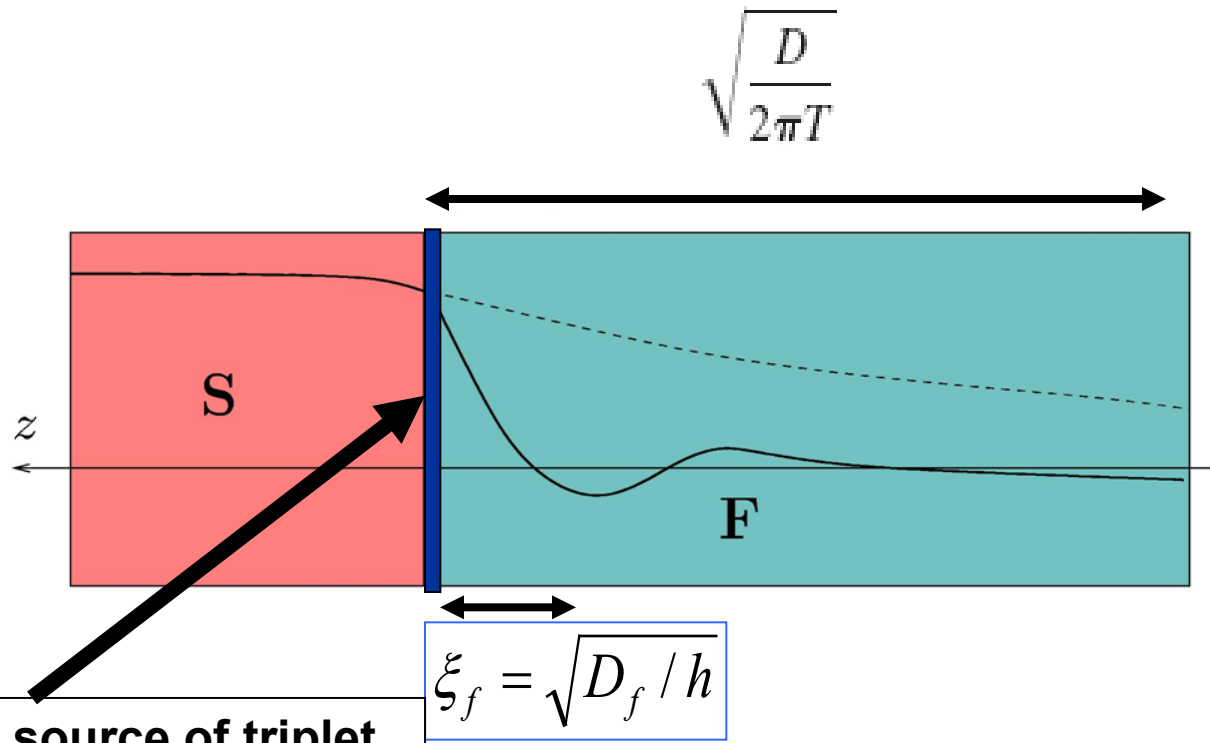
Triplet proximity effect may substantially increase the decaying length in the dirty limit.

The same, but larger amplitude

$$\sqrt{\frac{D}{2\pi T}}$$

No oscillations

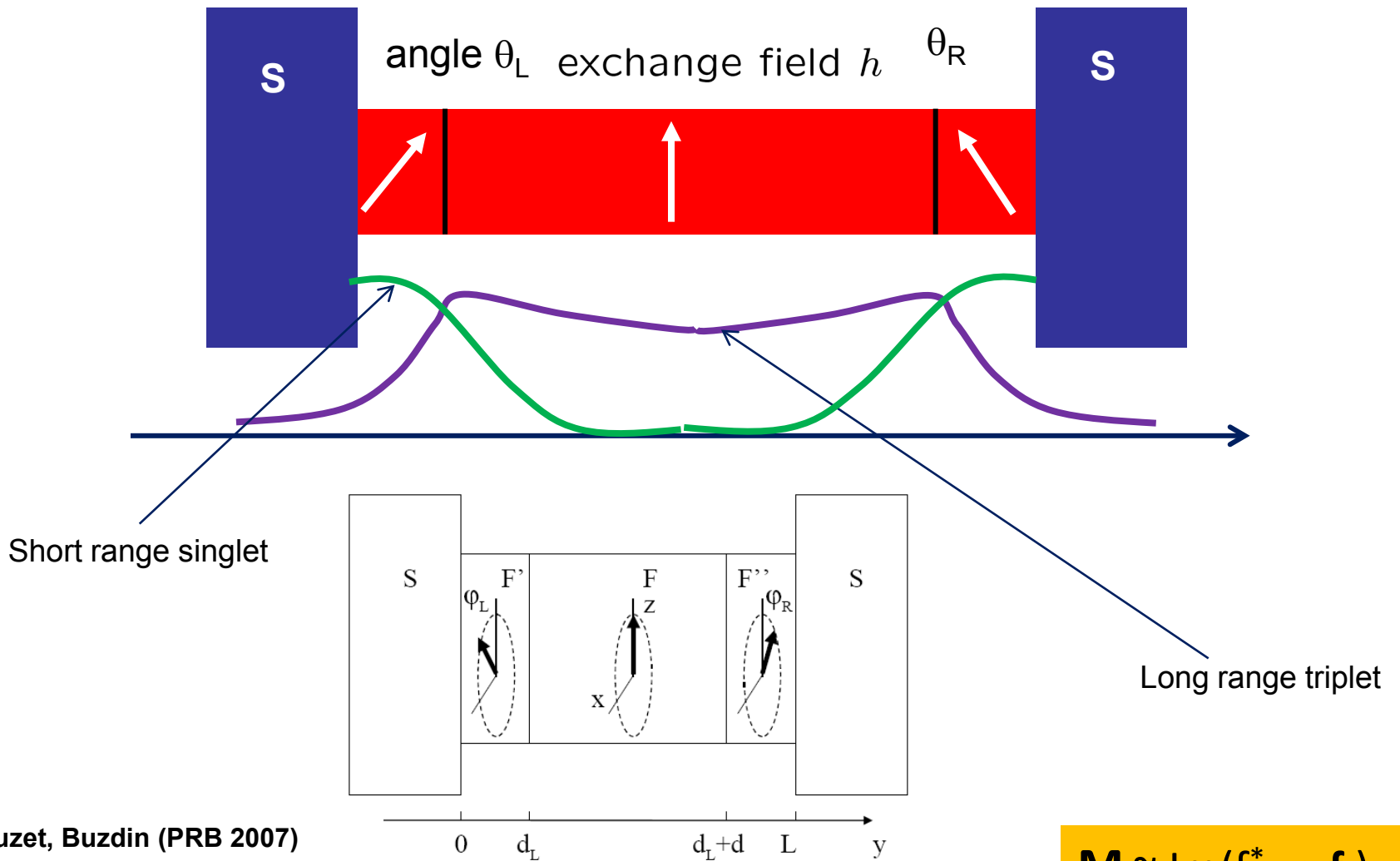




Some source of triplet correlations ?

Why difficult to observe ? Magnetic scattering and spin-orbit scattering are harmful for long ranged triplet component.

Magnetic disorder, spin-waves...



Houzet, Buzdin (PRB 2007)

FIG. 1: Geometry of S/F'/F/F''/S junction. The arrows indicate non-collinear orientations of magnetizations in each layer with thickness  $d_L, d, d_R$ , respectively ( $L = d_L + d + d_R$ ).

$$\mathbf{M} \sim \text{Im}(\mathbf{f}_s^* \cdot \mathbf{f}_t)$$

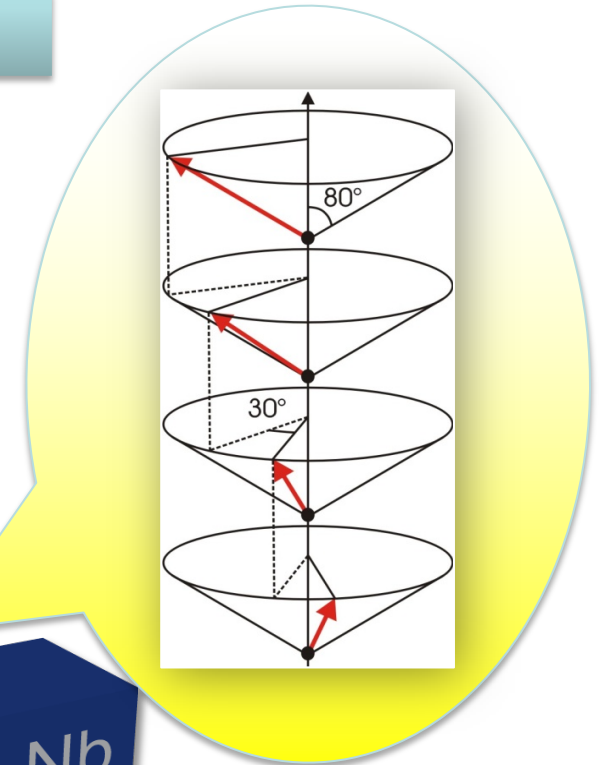
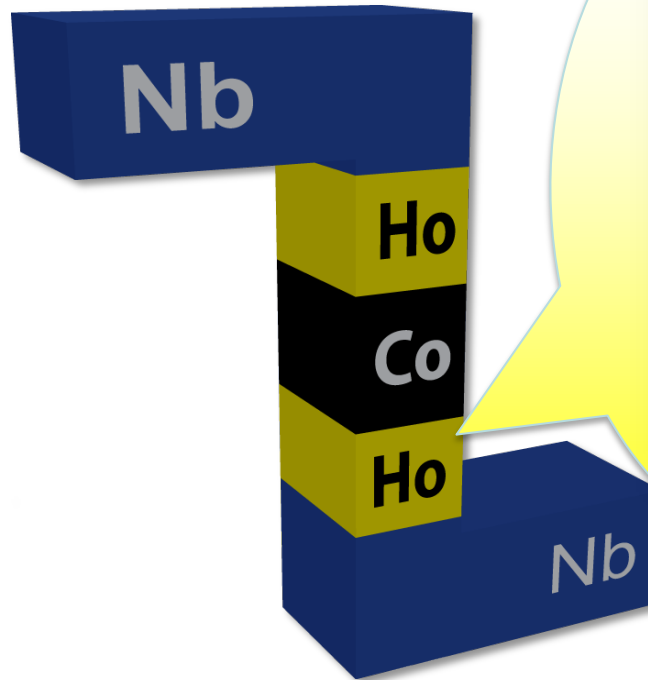
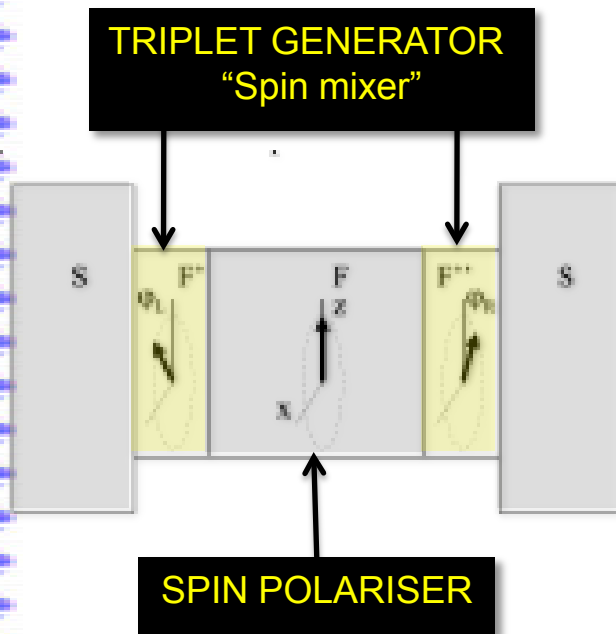
$$\xi_f \ll L \ll \xi_0$$

$$eR_F I_c = -\frac{2\Delta(T)^2 h_0^2}{\pi^3 T_c^3} \sin \theta_R \sin \theta_L$$

(+ small term)

# The direct evidences of the long range proximity effect

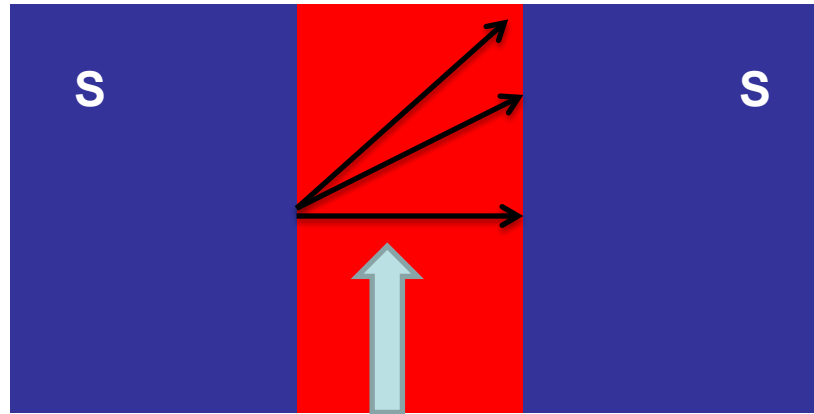
Blamire's group



GB Halasz, MG Blamire, JWA Robinson, *Physical Review B* (2011)

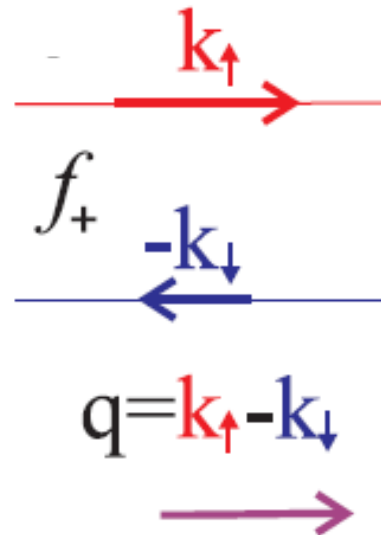
GB Halasz, JWA Robinson, J Annett, MG Blamire. *Physical Review B* **79**, 224505 (2009)

# Josephson S/F/ junction in ballistic regime



$$J_c \sim (\xi_F/d_F) \cos(d_F/\xi_F)$$

$d_F$



Phase accumulation

$$\gamma \sim qd,$$

averaging  $\exp(i\cdot\gamma)$  over  $d$   
(from  $d_F$  to  $\infty$ ) we have

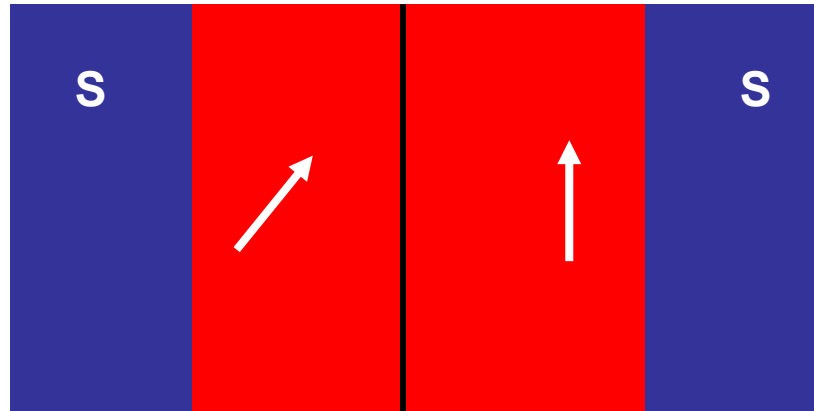
$$f_+ \sim (\xi_F/d_F) \cos(d_F/\xi_F)$$

$$\xi_F = v_F/2h$$

**Short ranged proximity effect  
in the clean limit !**

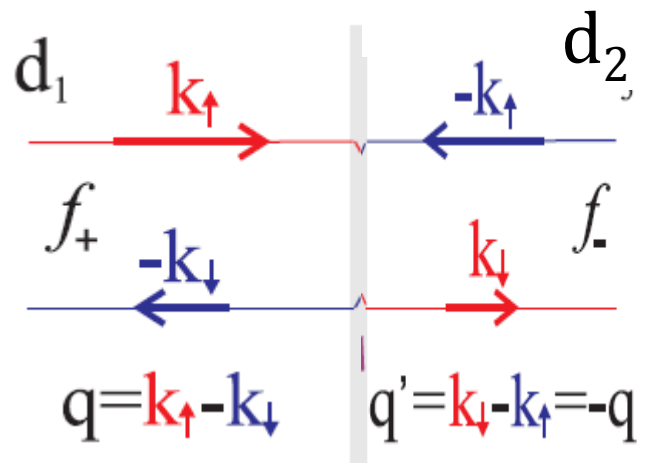
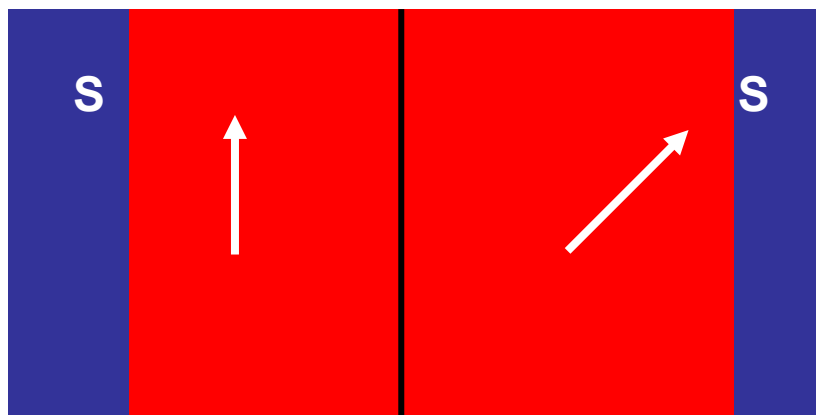
# Junctions with composite F interlayer

## Ballistic regime



Clean limit – antiparallel orientation, **Blanter, Hekking PRB (2004)**

Diffusive limit – arbitrary orientation, **Crouzy et al. PRB (2007)**



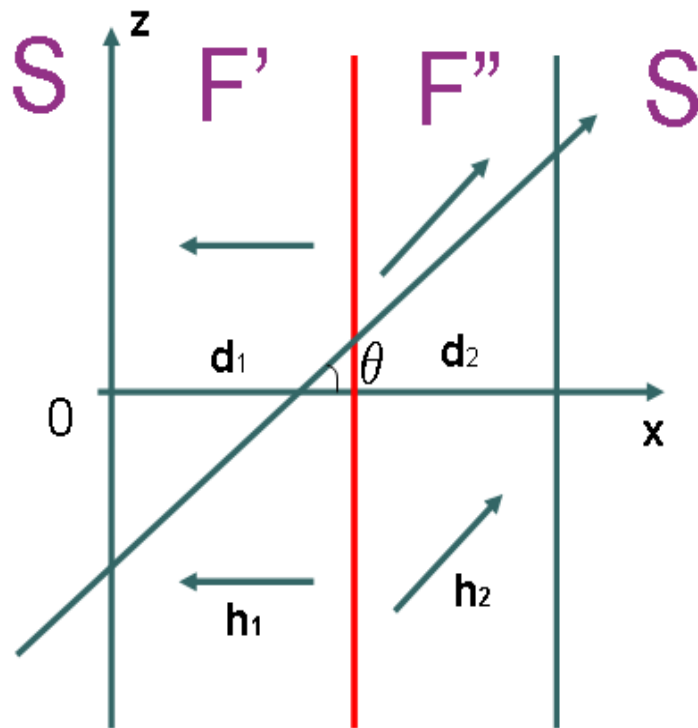
Phase accumulation

$$\gamma \sim qd_1 - qd_2$$

$$\gamma = 0 \text{ at } d_1 = d_2$$

A. Melnikov, et al, PRL (2012)

**Domain walls with  
collinear and non-collinear magnetic moments.  
Compensation of the phase gain along the trajectories.**



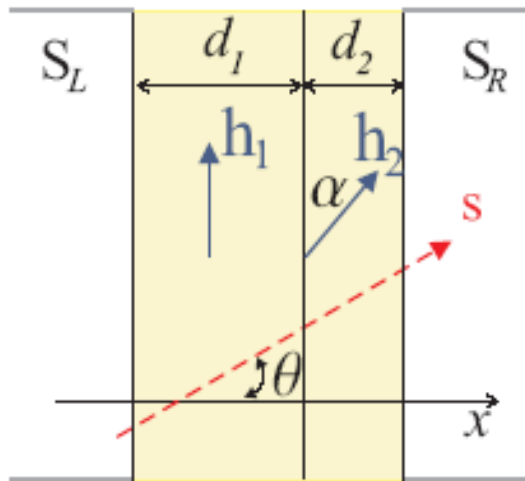
For  $d_1=d_2$   
angle between exchange field directions

$$I(\alpha) = I_{SFS} \cos^2 \frac{\alpha}{2} + I_{SNS} \sin^2 \frac{\alpha}{2}$$

Independent of the exchange field

$$I_{SFS} \ll I_{SNS}$$

For  $d_1 \neq d_2$  the higher harmonics (2,4...) are long ranged – **Trifunovic, PRL, 2011**

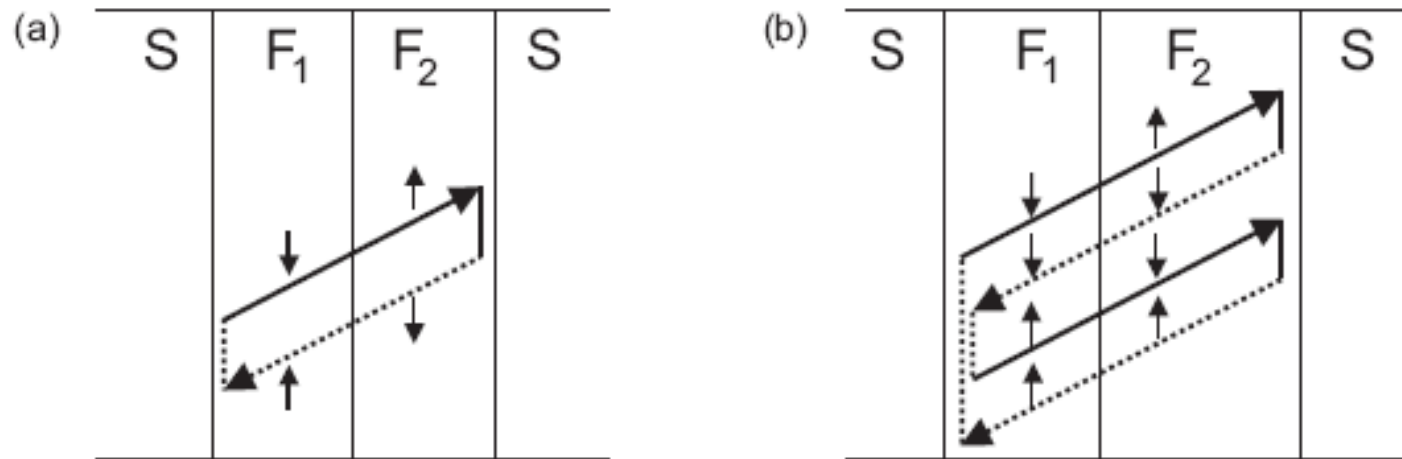


$$I_1 = \left[ \cos^2 \frac{\alpha}{2} I_{c1} \left( \frac{d_1 + d_2}{\xi_h} \right) + \sin^2 \frac{\alpha}{2} I_{c1} \left( \frac{d_1 - d_2}{\xi_h} \right) \right] \sin \varphi$$

$$\delta I_{c2} = \frac{a_2 \sin^2 \alpha}{2} \sin 2\varphi$$

$$a_2 \sim (\Delta/T_c)^4$$

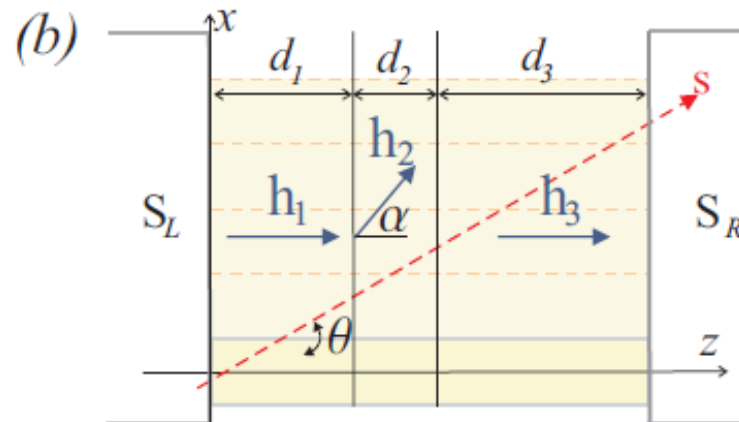
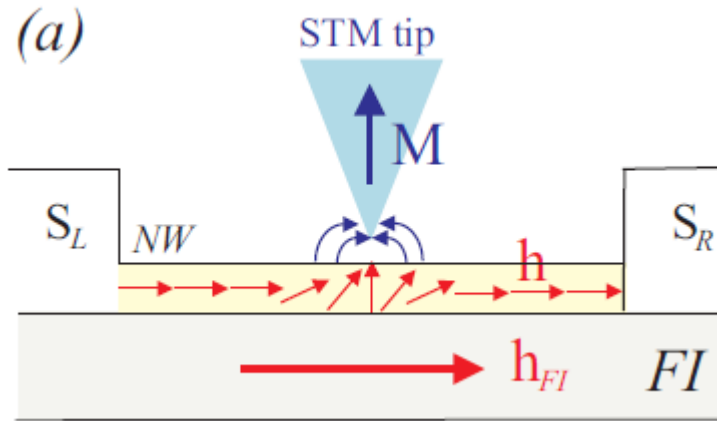




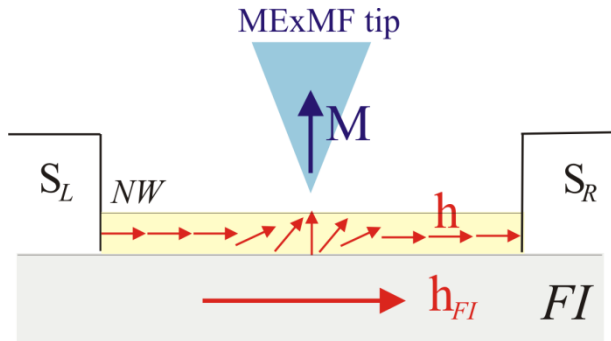
**Abb. 13.2.** The examples of the closed electron (straight lines) and hole (dashed lines) trajectories for the **Andreev reflection** which have no phase accumulation. For such trajectories averaging over the angles does not lead to the destructive interference. The vertical arrows indicate the spin direction for each part of the trajectory. (a) Possible trajectory which provides the phase compensation for equal thicknesses  $d_1 = d_2$  and give rise to the long ranged first harmonic of the current-phase relation. (b) Possible trajectory which provides the phase compensation for arbitrary thicknesses of the  $F_1$  and  $F_2$  layers and gives rise to the long ranged second harmonic of the current-phase relation.

# Stimulation of a long ranged singlet superconductivity in SFS weak links by the magnetic gate

A. Samokhvalov, R. Shekter and A. Buzdin, Nat. Sci. Rep. (2015)



# SFS constriction with the magnetic gate

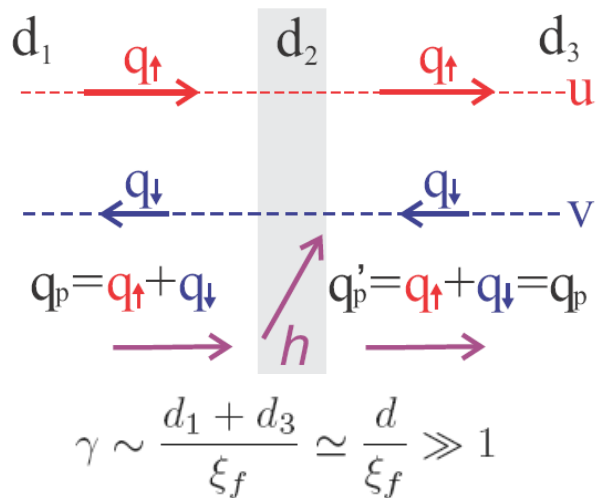


## Requirements:

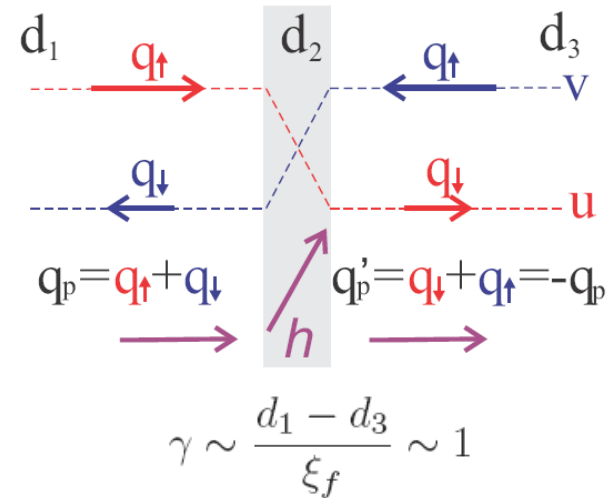
- Large mean free path;
- Weak spin-orbit interaction;
- Strong exchange splittings;

## Cooper pair scattering

no spin-flip transition



with spin-flip transition

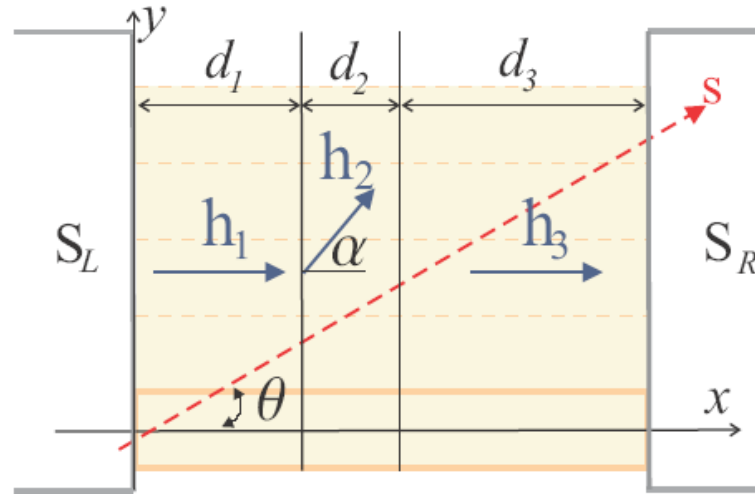


$$d_2 \ll d_1, d_3$$

Josephson transport is suppressed

Long-range Josephson transport

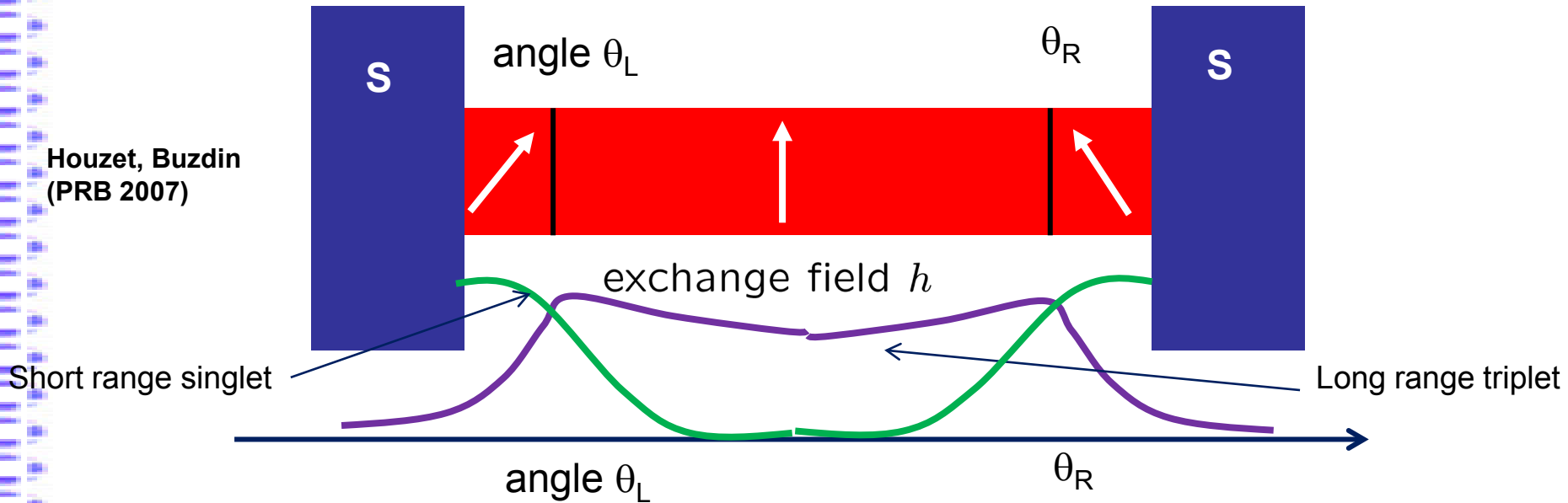
# Josephson current in SFS trilayers



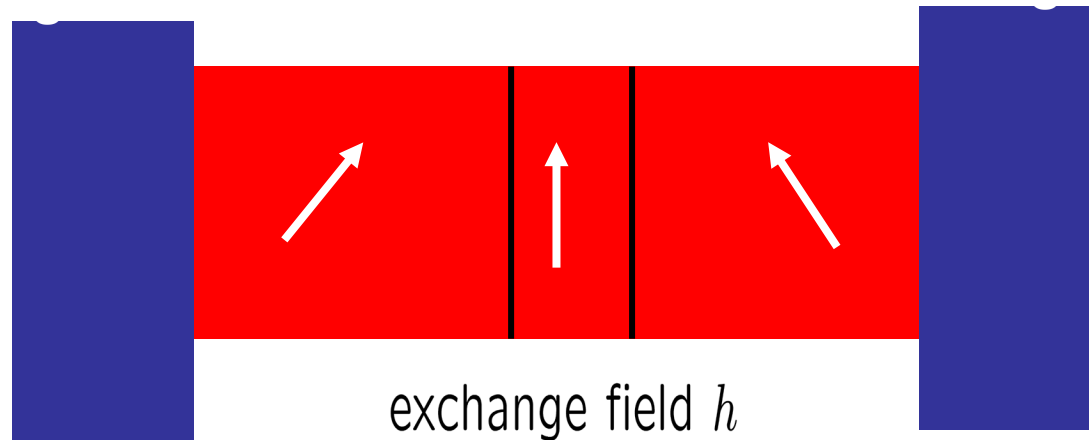
$$\hat{f}(d/\cos\theta) = \hat{T}_0(d_3/\cos\theta) \otimes \hat{T}_\alpha(d_2/\cos\theta) \otimes \hat{T}_0(d_1/\cos\theta) \otimes \hat{f}_0$$

$$f_s^{LR} \equiv (\cos\gamma)^{LR} = -\frac{1}{2} \sin^2 \alpha \left[ 1 - \cos\left(\frac{d_2}{\xi_f}\right) \right] \cos\left(\frac{d_1 - d_3}{\xi_f}\right)$$

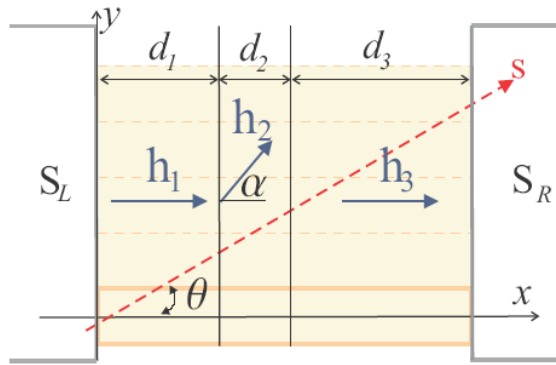
# Opposite to the case of the long ranged triplet current!



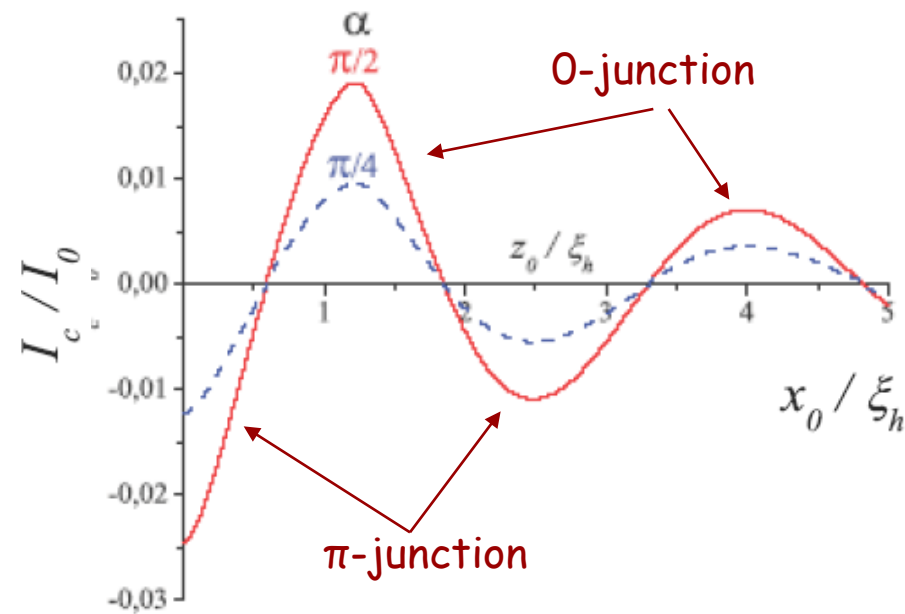
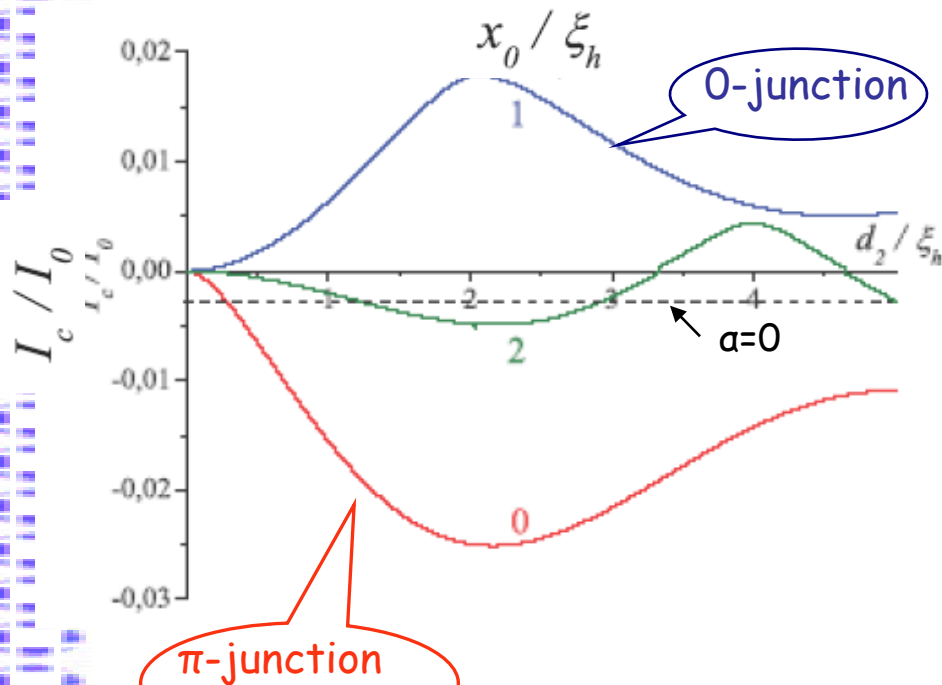
## Long ranged singlet current



# Josephson current in SFS trilayers



$$I_c = \max\{I_1 + I_2\}$$



$$\alpha = \pi/2$$

$$I_0 = (4eT_c N / \hbar) (\Delta / T_c)^2$$

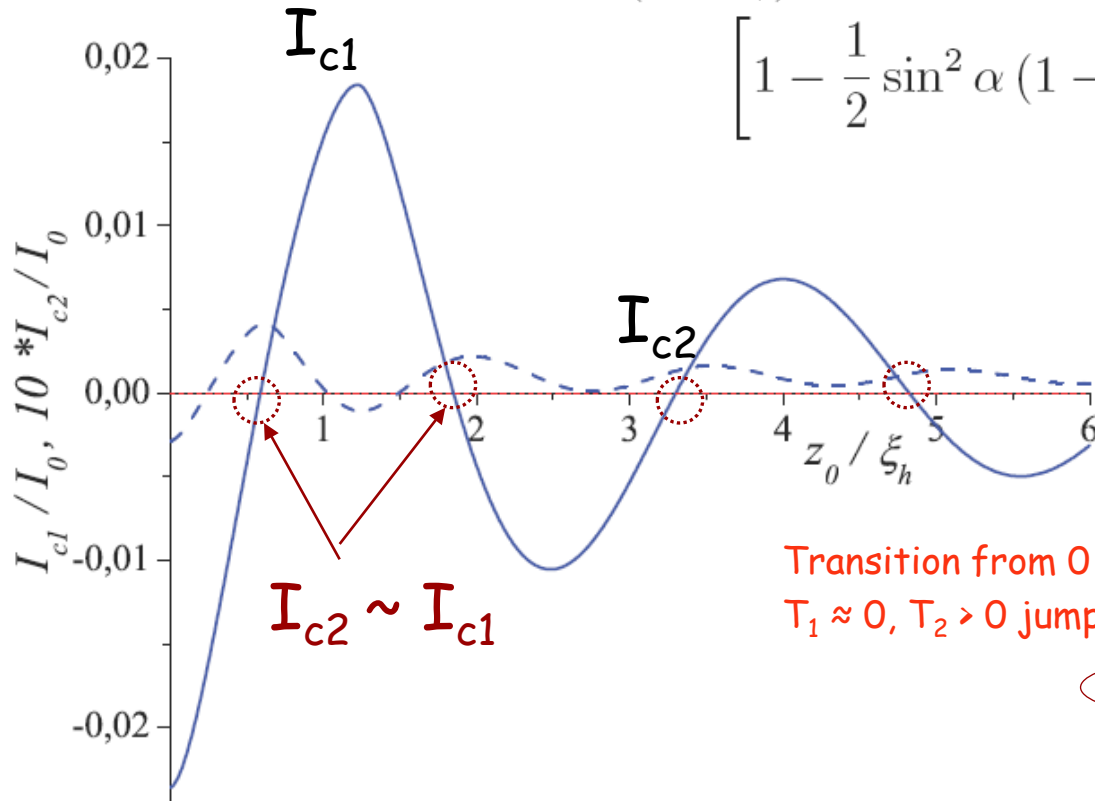
$$T = 0.9T_c; d = 20\xi_h$$

# Second harmonic contribution

$$I_2^{LR} = I_{c2}^{LR} \sin 2\varphi,$$

$$I_{c2}^{LR} = |a_2| T_2, \quad T_2 = -2 \int_0^{\pi/2} d\theta \sin \theta \cos \theta (\cos 2\gamma)^{LR}$$

$$(\cos 2\gamma)^{LR} = -\sin^2 \alpha (1 - \cos \delta_2) \times \left[ 1 - \frac{1}{2} \sin^2 \alpha (1 - \cos \delta_2) \left( 1 + \frac{1}{2} \cos(4\delta_z) \right) \right]$$



at  $0-\pi$  transition ( $I_{c1} \rightarrow 0$ )  
 $I_{c2} > 0$

$I_{c2} \sim I_{c1}$

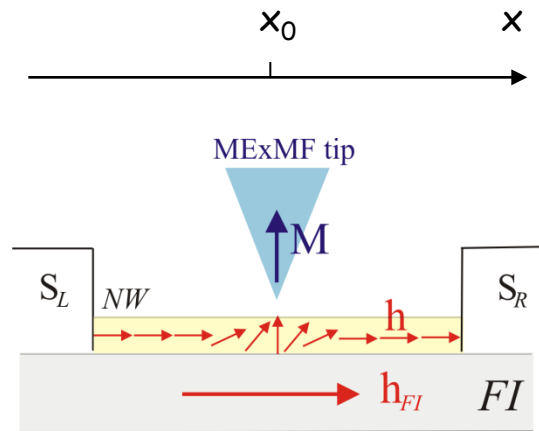
Transition from 0 to  $\pi$  state of the junction  
 $T_1 \approx 0, T_2 > 0$  jump from 0 to  $\pi$  state

$\varphi$  - junction

$$I_0 = (4eT_c N / \hbar) (\Delta / T_c)^2$$

$$T = 0.9T_c; d = 20\xi_h$$

# SFS constriction + magnetic probe = quantum electromechanical system



$$I = a_1 T_1(x_0) \sin \varphi = I_c(x_0) \sin \varphi$$

$$E_J(x_0) = -\frac{\Phi_0 I_c(x_0)}{2\pi c} \cos \varphi$$

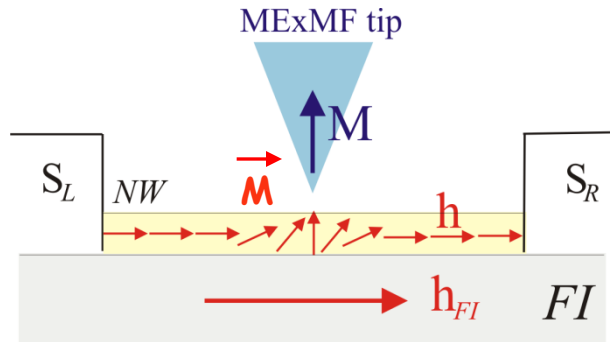
$$U(x_0) \sim -I_c(x_0) \cos \varphi$$

Sensitive position detection:  $\Delta x_0 \sim \xi_f$   
 = (1-10) nm

Coupling the Josephson current oscillations with mechanical modes of the tip.



# Magnetic Moment Manipulation by a Josephson Current



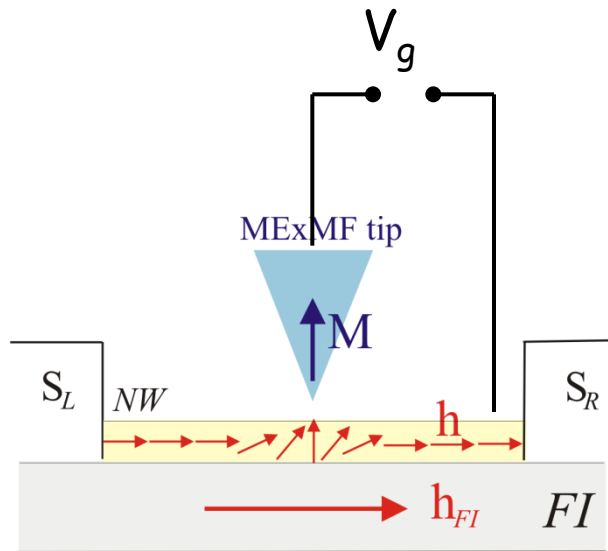
$$I = a_1 T_1(\vec{M}) \sin \varphi = I_c(\vec{M}) \sin \varphi$$

$$E_J(\varphi, \vec{M}) = -\frac{\Phi_0 I_c(\vec{M})}{2\pi c} \cos \varphi$$

$$E(\varphi, \vec{M}) = -\frac{\Phi_0}{2\pi} \varphi I - \frac{\Phi_0 I_c(\vec{M})}{2\pi c} \cos \varphi + E_M(\vec{M})$$

- ✓ Superconducting current acts as a direct driving force on the magnetic moment  $\mathbf{M}$ ;
- ✓ ac Josephson effect generates a magnetic precession providing then a feedback to the current;
- ✓ Magnetic dynamics result in several anomalies of current-phase relations (second harmonic, dissipative current)

# Electric biasing of the magnetic gate



$V_g$  increases



depletion region beneath the tip



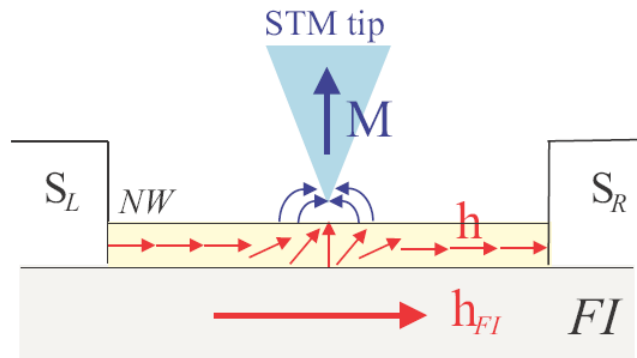
$V_F$  &  $\xi_f = \frac{\hbar V_F}{2h}$  decrease



$I_c \sim \alpha^2 (d_2 / \xi_f)^2$  increases

For thin domains the critical current  $I_c$  increases with the gate voltage  $V_g$ , and the local depletion of F barrier should result in the stimulation of the superconductivity.

# SFS constriction with the magnetic gate



## Requirements:

- Large mean free path;
- Weak spin-orbit interaction;
- Strong induced exchange splittings;

**NW:** Carbon nanotubes, graphene sheets, InSb nanowires ( $g \sim 50$ ):  
Bi nanowires.

**FI(FM):** EuO ( $\text{Eu}^{2+}$ ), Fe, Co, Ni

EuO / Graphene ( $V_F \sim 10^8$  sm/s)

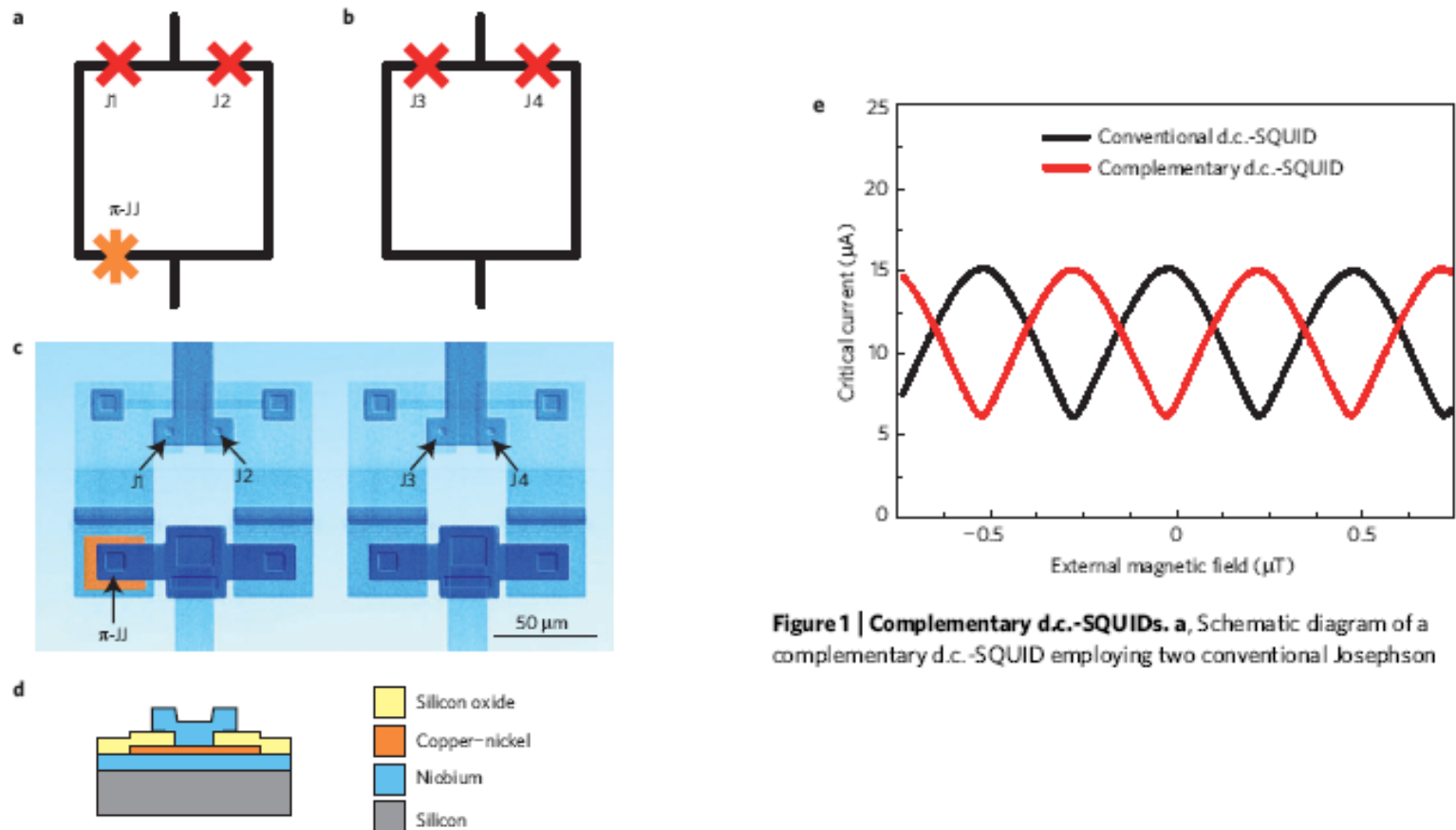
mean free path:  $\sim 1 \mu\text{m}$

spin-orbit interaction:  $\sim 1 \mu\text{eV}$  (spin-flip length:  $\sim 1 \mu\text{m}$ )

exchange splitting  $\sim 5\text{-}10$  meV (estimate) ( $\xi_f \sim 0.1 \mu\text{m}$ )

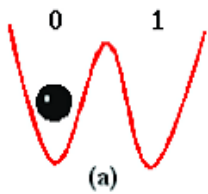
# Implementation of superconductor/ferromagnet/superconductor $\pi$ -shifters in superconducting digital and quantum circuits

A. K. Feofanov<sup>1</sup>, V. A. Oboznov<sup>2</sup>, V. V. Bol'ginov<sup>2</sup>, J. Lisenfeld<sup>1</sup>, S. Poletto<sup>1</sup>, V. V. Ryazanov<sup>2</sup>, A. N. Rossolenko<sup>2</sup>, M. Khabipov<sup>3</sup>, D. Balashov<sup>3</sup>, A. B. Zorin<sup>3</sup>, P. N. Dmitriev<sup>4</sup>, V. P. Koshelets<sup>4</sup> and A. V. Ustinov<sup>1\*</sup>

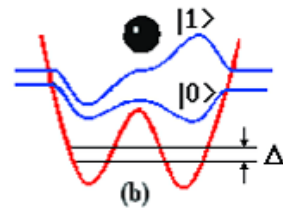


**Figure 1 | Complementary d.c.-SQUIDs.** **a**, Schematic diagram of a complementary d.c.-SQUID employing two conventional Josephson

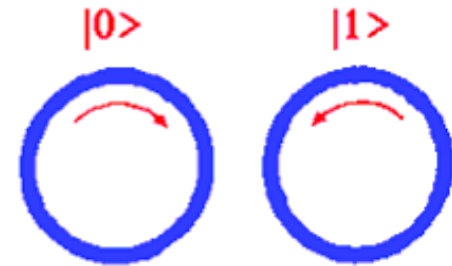
# Superconducting phase qubit



Digital bit

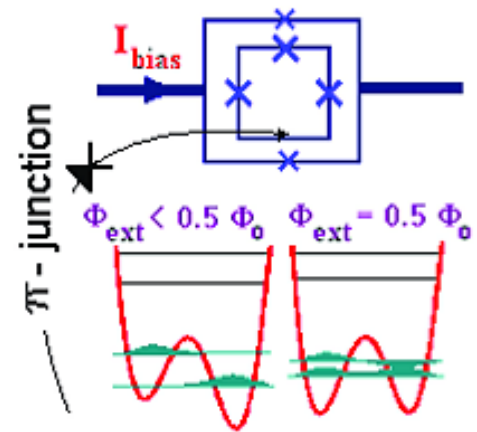
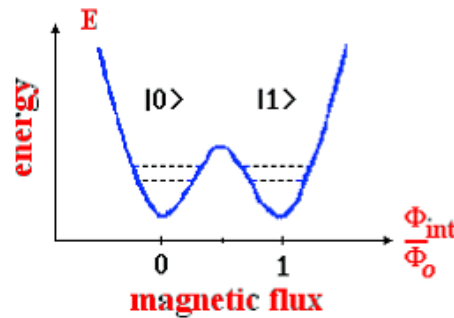
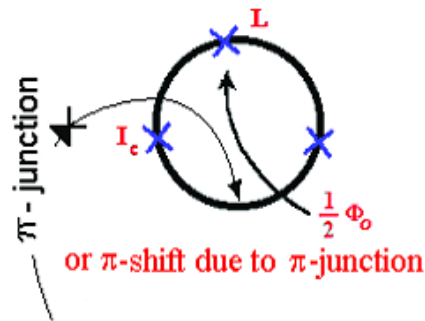


Quantum bit



$$\Phi_{\text{ext}} = \Phi_0 / 2$$

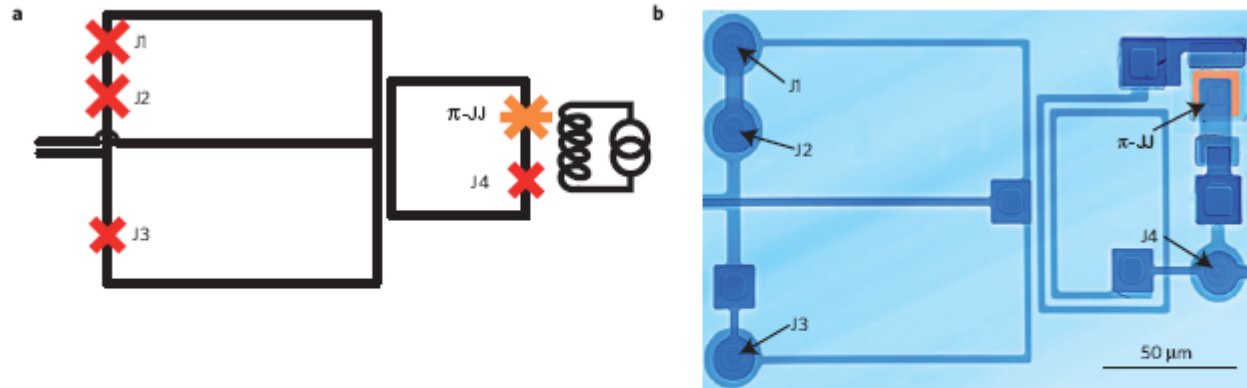
or  $\pi$ -shift due to  $\pi$ -junction



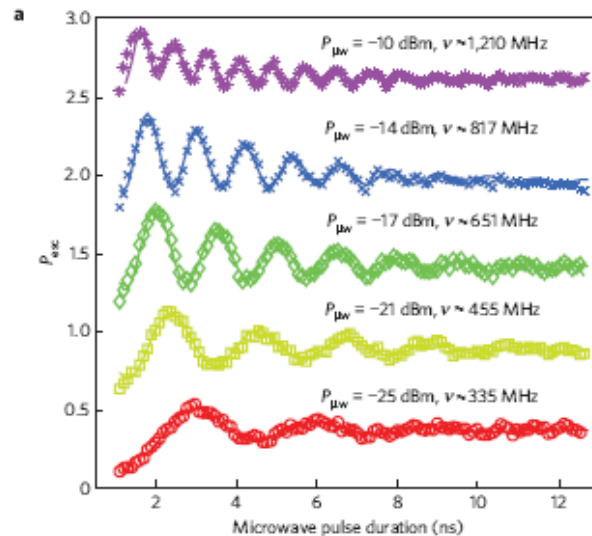
qubit operation

# Implementation of superconductor/ferromagnet/superconductor $\pi$ -shifters in superconducting digital and quantum circuits

A. K. Feofanov<sup>1</sup>, V. A. Oboznov<sup>2</sup>, V. V. Bol'ginov<sup>2</sup>, J. Lisenfeld<sup>1</sup>, S. Poletto<sup>1</sup>, V. V. Ryazanov<sup>2</sup>, A. N. Rossolenko<sup>2</sup>, M. Khabipov<sup>3</sup>, D. Balashov<sup>3</sup>, A. B. Zorin<sup>3</sup>, P. N. Dmitriev<sup>4</sup>, V. P. Koshelets<sup>4</sup> and A. V. Ustinov<sup>1\*</sup>



**Figure 3 | Self-biased phase qubit.** **a**, Schematic diagram of a phase qubit circuit used to test the decoherence properties of the  $\pi$ -junction. The qubit is realized by the central loop with embedded conventional and  $\pi$ -Josephson junctions. The larger loop to its left is a d.c.-SQUID for qubit readout. To the right of the qubit is a coupled weakly flux bias coil. **b**, Scanning electron microscope picture of the realized phase qubit employing a  $\pi$ -junction in the qubit loop. The flux bias coil is not shown.



**Figure 4 | Rabi oscillations between the ground and the excited qubit states resulted from resonant microwave driving.** **a,b**, Rabi oscillations observed in the phase qubit with an embedded  $\pi$ -junction (**a**) and a conventional phase qubit made on the same wafer as a reference (**b**). Each

# Conclusions

- **It is possible to stimulate a long ranged singlet superconductivity in SFS weak links in the ballistic regime by the spin-exchange scattering.**
- **These phenomena opens a way to control the properties of SFS junctions and inversely to manipulate the magnetic moment via the Josephson current.**